

RoHS

REV.	DESCRIPTION	DATE
A	ISSUE	Nov/06/2024

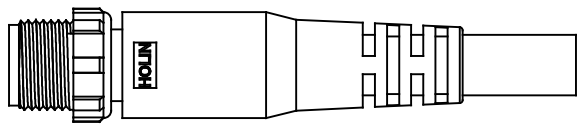
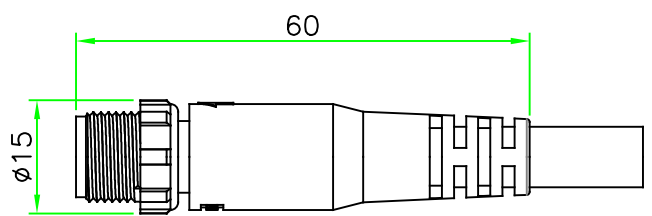
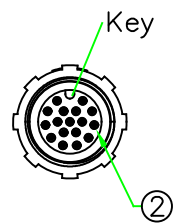
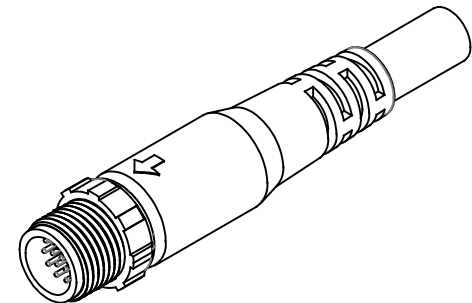
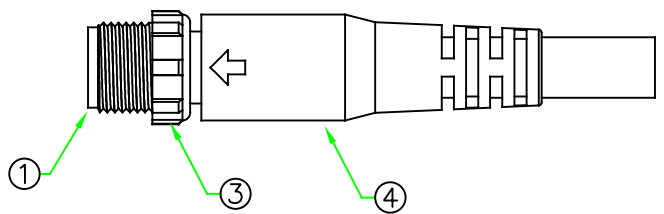

NOTES:

- ELECTRICAL CHARACTERISTICS:
 CURRENT RATING: 1.5A / 2A / 4A
 TEMPERATURE RANGE: -25°C TO +85°C
 DIELECTRIC WITHSTANDING VOLTAGE:
 500V AC FOR ONE MINUTE

- HOW TO ORDER: A12x-P1xxSM
 - 02 - 2 PINS 10 - 10 PINS
 - 03 - 3 PINS 11 - 11 PINS
 - 04 - 4 PINS 12 - 12 PINS
 - 05 - 5 PINS 13 - 13 PINS
 - 06 - 6 PINS 14 - 14 PINS
 - 07 - 7 PINS 15 - 15 PINS
 - 08 - 8 PINS 16 - 16 PINS
 - 09 - 9 PINS 17 - 17 PINS

I - CURRENT RATING 1.5A
 N - CURRENT RATING 2A
 D - CURRENT RATING 4A

※Cable specification and length can be customized.
 ※Pin Assignment Next Page.

No.	PART NAME	DESCRIPTION	COLOR	Q'TY	REMARKS
4	OVERMOLD	PU or PVC.	BLACK	1	
3	RING NUT	Nylon+GF.	BLACK	1	
2	CONTACT	Brass , 6 u" Gold Plated. Male Contact.		N	
1	CONNECTOR	M12 A-Coding Male Connector Insert. Nylon+GF.	BLACK	1	

HOLIN® HTP ASIA TECHNOLOGY CO., LTD.
 禾凌科技股份有限公司

UNIT: mm	TITLE :	M12 A-Coding Male
SCALE		All Plastic Molded Cable Ass'y
UNLESS OTHERWISE SPECIFIED TOLERANCES: XX, ±1.0 .X ±1.0 .XX ±0.5 .XXX ±0.25 ANGLE ± 1'	P/N:	A12x-P1xxSM
REV. A	SHEET	DWG.NO: A12x-P1xxSM
	1/2	DR. SIBYL CH. JAMES AP.

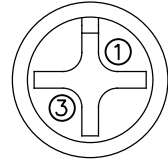

A12D-P102SM

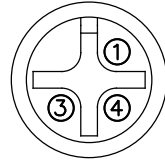

A12D-P103SM

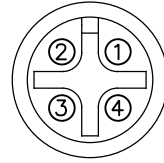

A12D-P104SM

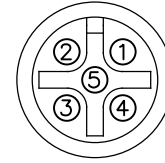

A12D-P105SM

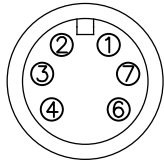

A12N-P106SM

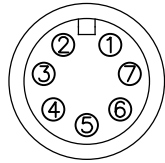

A12N-P107SM

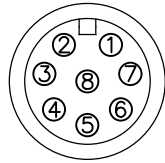

A12N-P108SM

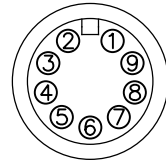

A12I-P109SM

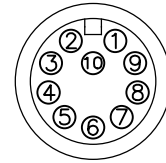

A12I-P110SM

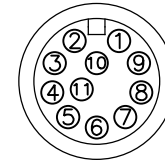

A12I-P111SM

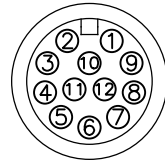

A12I-P112SM

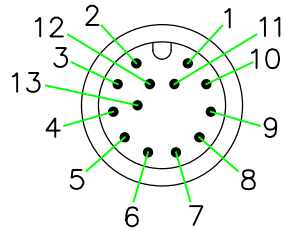

A12I-P113SM

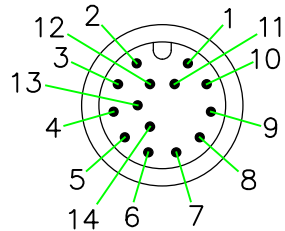

A12I-P114SM

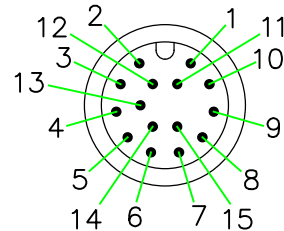

A12I-P115SM

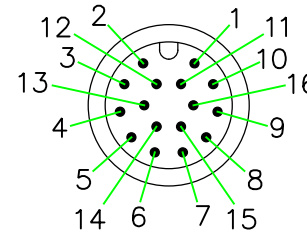

A12I-P116SM

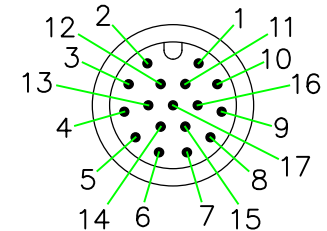

A12I-P117SM

PIN ASSIGNMENT FRONT VIEW
(前視圖)

HOLIN® HTP ASIA TECHNOLOGY CO., LTD. 禾凌科技股份有限公司			
	UNIT: mm	TITLE : M12 A-Coding Male All Plastic Molded Cable Ass'y	
SCALE	1:1		
UNLESS OTHERWISE SPECIFIED TOLERANCES: XX, ±1.0 .X ±1.0 .XX ±0.5 .XXX ±0.25 ANGLE ± 1°		P/N: A12x-P1xxSM	DR. SIBYL
REV. A	SHEET 2/2	DWG.NO: A12x-P1xxSM	CH. JAMES
			AP.